

Data Sheet



Article number: 201281300

Description: E+G Handwheel
GN 322-125-K14-R

Measures

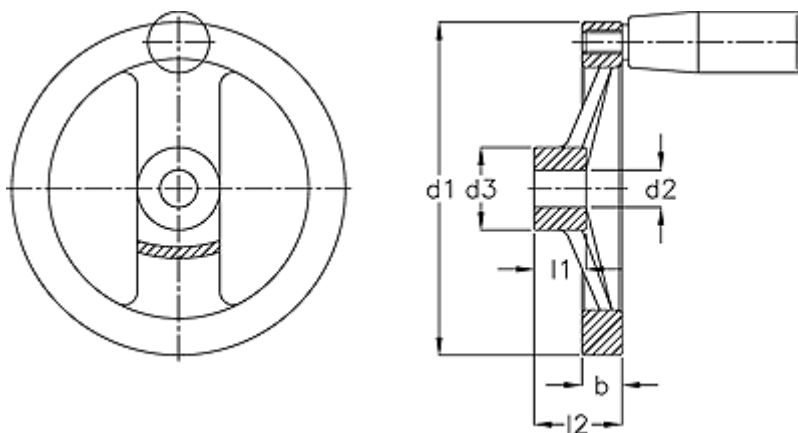

b	= 15.0
d1	= 125
d2 H7	= 14
d3	= 31
Handle	= 22
l1	= 18
l2	= 33